

DuraGlo™ Universal Replacement Igniter Kit Installation Instructions

Please read the entire instruction booklet before beginning the DuraGlo™ replacement igniter installation.

The DuraGlo™ igniter kit uses a universal snap apart bracket and an extension bracket. The snap bracket **must** be modified to suit your specific appliance design. Refer to the cross reference list and the pictorials in this sheet to determine the snap-apart bracket configuration required for your application. The extension bracket is used without modification. When using the extension bracket it is important that the existing gasket on the installed igniter be re-used with the new extension bracket from the DuraGlo™ kit.

WARNING: Failure to comply with the following warnings could result in personal injury and property damage.

It is recommended that the installation of the enclosed replacement product be performed by a licensed or qualified gas appliance service technician.

CoorsTek or its affiliates will not be responsible for injury or damage resulting from the installation of this product by an unqualified person.

Read the entire instruction booklet before installing the replacement product. Follow the instructions completely.

Shock Hazard: Turn off or disconnect the electrical power from the appliance before the installation of this product.

All wiring of the appliance must comply with the manufacturer's instructions and local and national electrical codes.

Fire and Explosion Hazards: Shut off the gas supply to the appliance before installing this product. Failure to shut off the gas supply could result in fire or explosion during the installation and testing of the product.

CAUTION

With appropriate care, maintenance, and use, your hot surface igniter will provide years of dependable and trouble-free service. Nevertheless, the igniter is a wear part and it will become non-operational at the end of its life cycle. The length of its life cycle will depend on a variety of factors, including without limitation, the type of furnace you use, the length of your heating season, and the number of ignition cycles. Therefore, to help ensure continued operation of your furnace, we recommend an inspection of the igniter by a qualified service professional once a year, before the heating season begins, as part of a routine preventative maintenance program for your heating system.

DuraGlo™ Universal Replacement Igniter Kit Description:

The DuraGlo™ universal Silicon Nitride igniter kit contains the following materials:

1. Extension Bracket
2. Ceramic Wire Nuts (2)
3. Universal "Snap" Mounting Bracket
4. 120 Volt DuraGlo™ Silicon Nitride Igniter With 250 C Rated Wire Leads
5. Self-Tapping Mounting Screw
6. Instructions

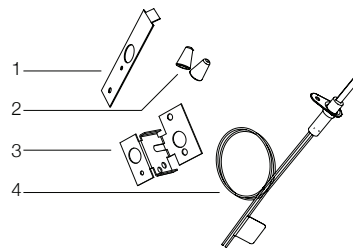

DuraGlo™ Igniter Dimensions (Inches)

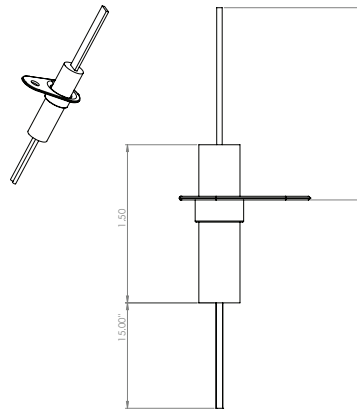

The DuraGlo™ universal kit replaces:

1. 120 Volt Flat Silicon Carbide Igniters
2. 120 Volt Round Spiral Silicon Carbide Igniters
3. 120 Volt Round Silicon Nitride Igniters
4. 120 Volt Flat (Large and Small Format) Silicon Nitride Igniters

Over 200 applications can be replaced by the materials included in the DuraGlo™ universal igniter kit.

The major replacement applications are detailed on the kit label cross reference list.

The DuraGlo™ kit is suitable for use with most 120 volt appliance controls. The DuraGlo™ kit cannot be used to replace igniters that operate with amperage "proven" control systems.

Snap Bracket Details:

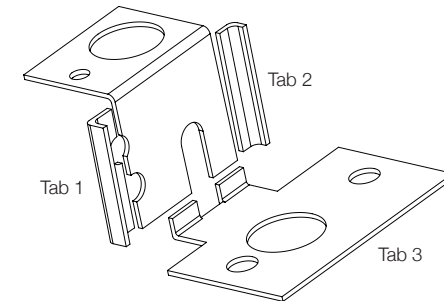

Step by Step Installation Instructions:

1. Disconnect the appliance from the electrical and gas supplies.
2. Unplug the igniter to be replaced from the appliance wiring harness and remove the igniter. Remember to save the original igniter mounting screw(s) as this will be required when installing the new DuraGlo™ igniter assembly.
3. Examine the existing igniter configuration and check the cross reference list and/or igniter assembly pictorials to determine the bracket configuration required.
4. Using pliers or a similar tool, snap off the bracket tabs (labeled 1, 2, and 3) necessary to properly configure the bracket.
5. Install the correctly configured bracket to the appliance with the original igniter mounting screw.
6. Cut off the original igniter connector on the appliance wire harness and strip the two wire leads to be connected to the DuraGlo™ igniter.
7. Install the DuraGlo™ igniter onto the replacement bracket using the tapping screw provided in the kit.
8. Confirm that the replacement igniter mounting is fitted properly. If the bracket has been configured properly, the new igniter position will be similar to the original igniter position.
9. Attach the wire leads from the igniter to the stripped leads on the wire harness using the wire nuts provided. Make sure no portion of the stripped wire ends are exposed outside of the wire nuts

Installation and Operation Confirmation:

1. If the gas burner assembly was removed or disconnected during the installation of the igniter, re-assemble and confirm that all of the electrical and gas connections are properly re-connected and tight.
2. Turn on the electrical and gas supplies to the appliance. Using a volt meter, confirm that the supply voltage to the appliance is correct. Using a leak checker, confirm that there are no gas leaks in the appliance piping.
3. With the back cover of the furnace still removed, turn on the furnace and set the thermostat to call for heat.
4. Observe the ignition sequence. The igniter will begin to glow and the gas valve will operate to supply gas to the burners. The igniters should not remain on for more than a few seconds after the burners light. Once the furnace is running properly, turn off the furnace and reinstall the back cover.
5. Cycle the furnace one or more times to make sure it is functioning properly.
6. Reset the thermostat to its normal settings. The installation is now complete.

Igniter Assembly Configurations

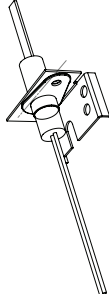
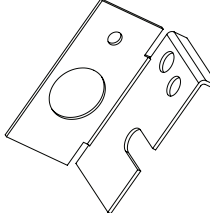
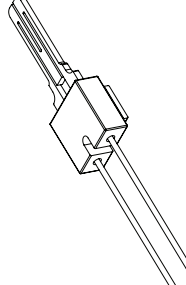
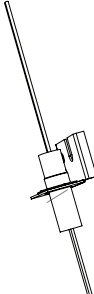
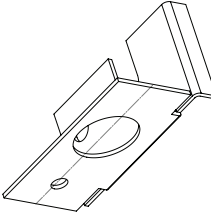
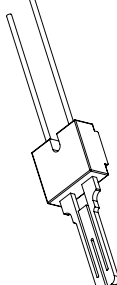
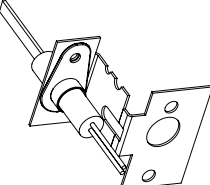
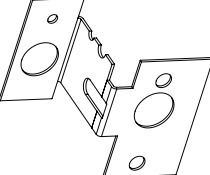
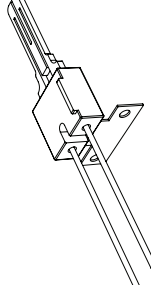
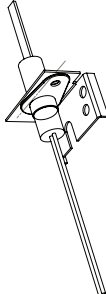
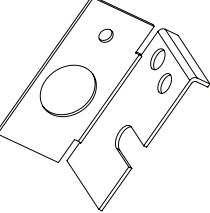
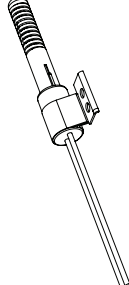
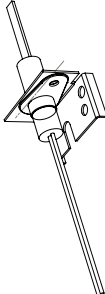
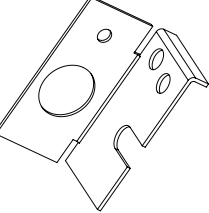
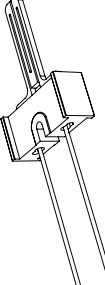
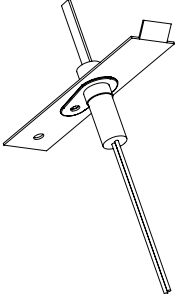
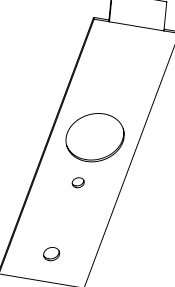
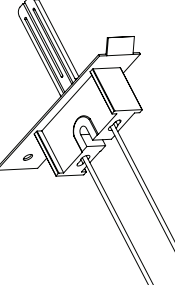
DuraGlo™ Igniter Assembly	Bracket	Silicon Carbide Igniter Assembly	
			<p>Igniter Assembly 1 The snap bracket - remove tabs 2 and 3</p>
			<p>Igniter Assembly 2 The snap bracket - remove tabs 1 and 3</p>
			<p>Igniter Assembly 3 The snap bracket - remove tabs 1 and 2</p>
			<p>Igniter Assembly 4 The snap bracket - remove tabs 2 and 3</p>
			<p>Igniter Assembly 5 The snap bracket - remove tabs 2 and 3</p>
			<p>Igniter Assembly 6 The extension bracket - no modification</p>